

SPECIFICATION OF HWCM-HDMI SERIES

FEATURES & APPLICATIONS

Lowprofile and very small size SMD Design,
 Wound Chip constructure with standard 0805 size,
 with best EMI suppression effect
 but least impact to HDMI signal wave form.
 Due to match with line impedance of 100 ohmline.



ORDERING CODE

HWCM - 2012 HDMI - 900 T
 (1) (2) (3) (4) (5)

- (1) PRODUCT TYPE CODE
- (2) PRODUCT SIZE CODE
- (3) DESIGN CODE
- (4) IMPEDANCE
- (5) TAPING

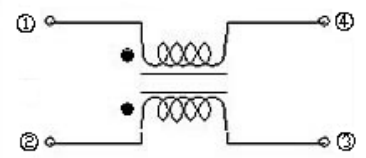
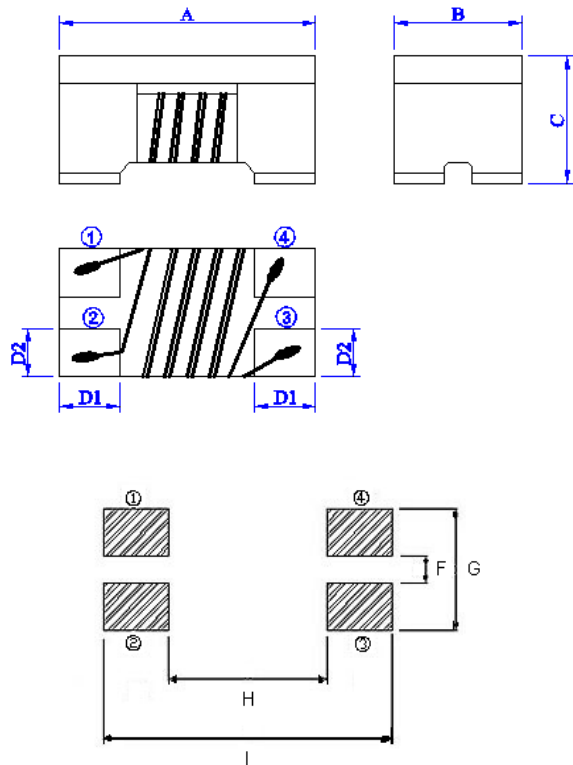

APPEARANCE & DIMENSIONS

UNIT:mm (inch)

SIZE CODE	A	B	C	D1 TYP	D2 TYP	F TYP	G TYP	H TYP	I TYP
HWCM-2012HDMI 0805	2.00±0.20 (0.079±0.008)	1.20±0.20 (0.047±0.008)	1.20±0.20 (0.047±0.008)	0.45 (0.018)	0.40 (0.016)	0.40 (0.016)	1.20 (0.047)	0.80 (0.031)	2.60 (0.102)



HaoHuaKe Technology Co., Ltd. Tel:0755-2101 7581 QQ: 2606 3546 22
 302, factory building No.1, fangmapu Xinfang street, Guihua community, Longhua District,
 Shenzhen, China

E-mail: hhk_shenzhen@126.com

Web Site:
<http://www.haohuake.cn>

COMMON MODE CHOKE → HWCM-2012HDMI SERIES

ELECTRICAL CHARACTERISTICS

ORDERING CODE	Impedance (Ω)	Tolerance ±%	Test Frequency (MHz)	DC Resistance (Ω)max	Rated Current (mA)max
HWCM-2012HDMI-400T	40	25%	100	0.25	400
HWCM-2012HDMI-670T	67	25%	100	0.25	400
HWCM-2012HDMI-900T	90	25%	100	0.30	400
HWCM-2012HDMI-121T	120	25%	100	0.30	370

HWCM-2012HDMI-400T

1. Electrical Characteristic Curve
2. TDR Impedance Curve (For HDMI)
3. Insertion Loss Curve (For HDMI)

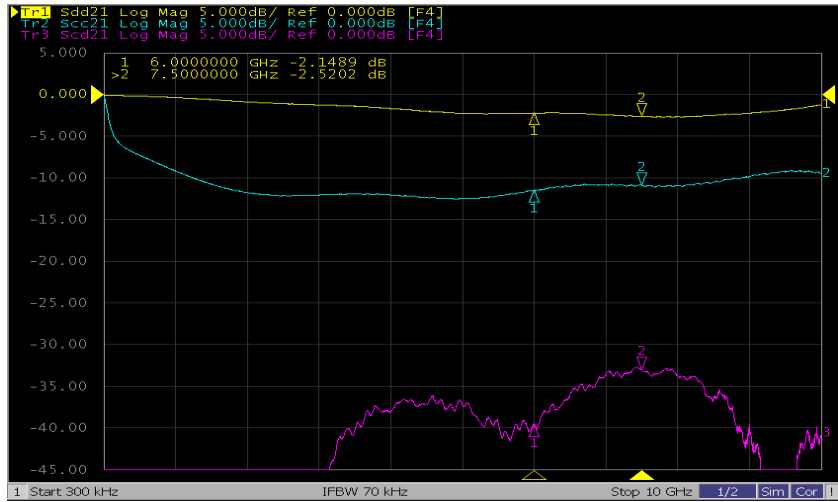
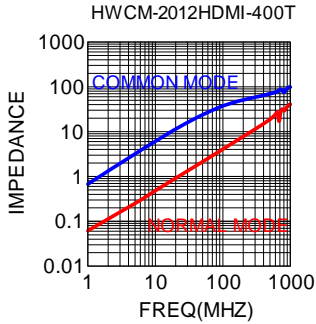

HWCM-2012HDMI-670T

1. Electrical Characteristic Curve
2. TDR Impedance Curve (For HDMI)
3. Insertion Loss Curve (For HDMI)

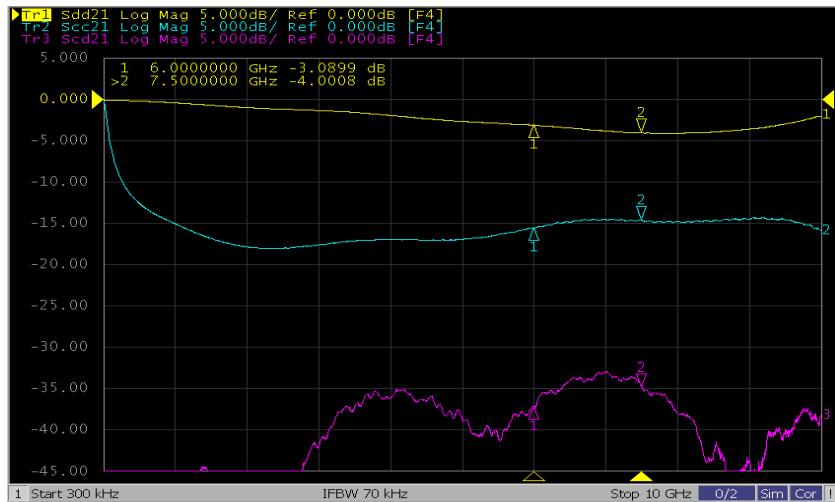
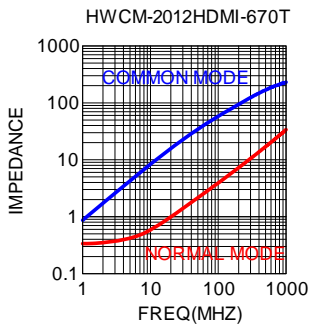

COMMON MODE CHOKE → HWCM-2012HDMI SERIES

HWCM-0805HDMI-900T

1. Electrical Characteristic Curve
2. TDR Impedance Curve (For HDMI)
3. Insertion Loss Curve (For HDMI)

HWCM-2012HDMI-900T

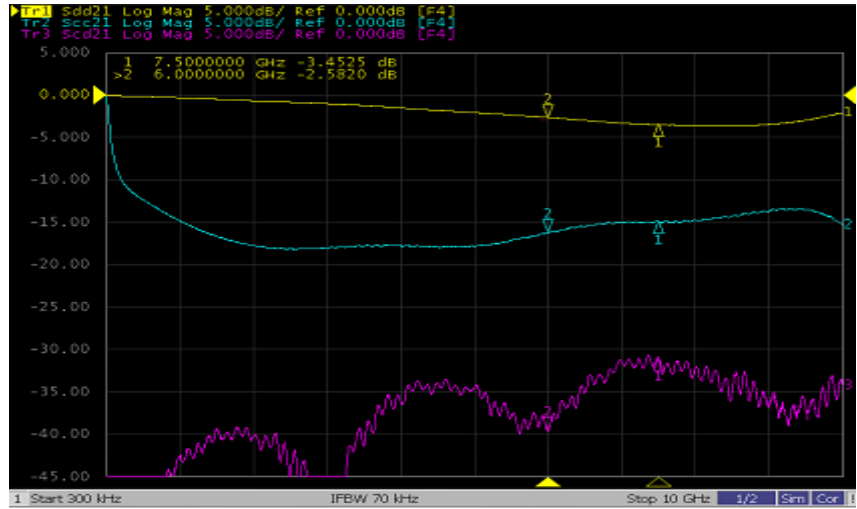
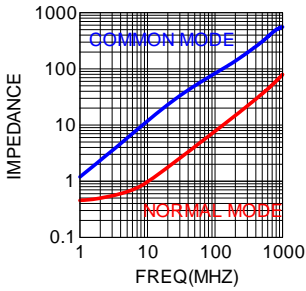

HWCM-2012HDMI-121T

1. Electrical Characteristic Curve
2. TDR Impedance Curve (For HDMI)
3. Insertion Loss Curve (For HDMI)

HWCM-2012HDMI-121T

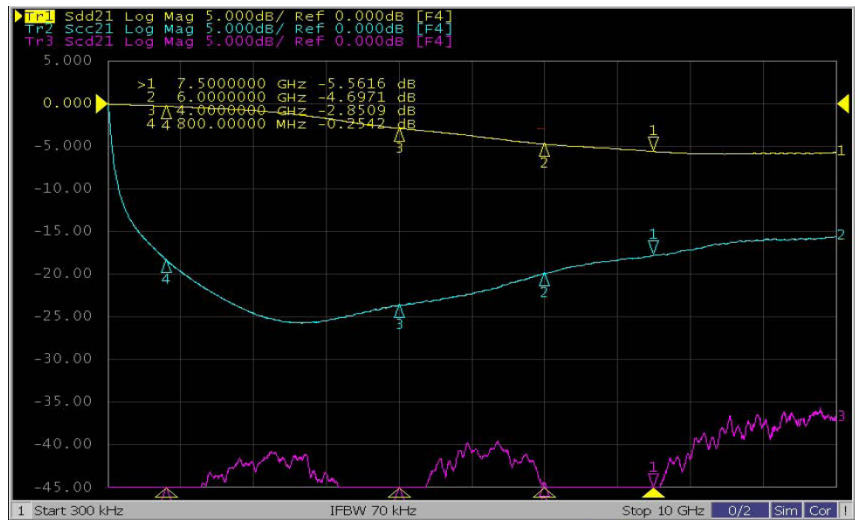
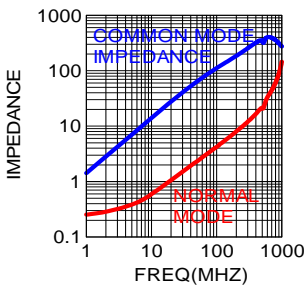

HaoHuaKe Technology Co., Ltd. Tel:0755-2101 7581 QQ:2606 3546 22
302, factory building No.1, fangmapu Xinfang street, Guihua community, Longhua District, Shenzhen, China

E-mail: hhk_shenzhen@126.com

Web Site: <http://www.haohuake.cn>